

# V2, V4 and V8 Thermostats

Self-acting Temperature Controls

0-3.4.01-L

Page 1 of 6



## TECHNICAL DATA

<b>Closing force</b>	400 N, 500 N and 800 N
<b>Capillary length</b>	3m to 21m
<b>Neutral zone</b>	1,5°C - 2,5°C
<b>Temperature range</b>	0 to 160°C (-30 to 280°C on request)

For linear valves up to DN150  
For heating or cooling valves

## APPLICATIONS

The temperature controller, which consists of a thermostat and a valve, is used for controlling the temperature in central heating systems, district heating systems, industrial plants or industrial processes and in marine systems. It can be used for the control of cold or hot water, steam or oil in heating as well as cooling systems.

## DESIGN

### Thermostat

A thermostat consists of a sensor and a capillary tube, filled with liquid, and an adjusting cylinder. The thermostat type designations and technical data are specified in fig. 2. With temperatures above 170°C, a cooling unit must be fitted between the valve and the thermostat - see fig. 1. The thermostat is self-acting and works on the principle of liquid expansion, it is sturdy in its design, and works with a large closing force - see fig. 2

### Sensor

The following sensor types are available - see fig. 4:

- 4.1. Rod sensor in copper or stainless steel and spiral sensor in copper with threaded connection according to ISO R7/1.
- 4.2. Spiral sensor (copper only) with air duct flange.
- 4.3. Rod/spiral sensor with steel flange DN 50, PN 40 and DN 50, PN 160.
- 4.4. Sensor without connection. Usually used with capillary pack box for temperature control in tanks.

### Capillary Tube

The capillary tube is made of copper, stainless steel, or of PVC-coated copper - see fig. 3, but can also be delivered with a flexible iron tube protection.

### Valve

A wide range of valve types for heating as well as cooling systems can be delivered. For quick and accurate valve selection and valve sizing, we advise you to visit our website [www.cloriuscontrols.com](http://www.cloriuscontrols.com) and select our sizing software Quick Choice 4.

## FEATURES

- No external power required.
- For use in hazardous area.
- Simple design secures reliable controls and reduces costly downtime.
- Customizable, User friendly, Plug & Control
- No special tools needed for service
- Low installation cost
- Sturdy and reliable

## FUNCTION

The adjusting cylinder of the thermostat is set at the required temperature for the heating medium in °C or °F. This setting can be fixed, if required. The temperature control is carried out by the thermostatically controlled valve reducing or increasing the flow of the heating (or cooling) medium. The sensor and the capillary tube, which are filled with a liquid, constitute - together with the adjusting cylinder - a closed system. If the temperature of a medium to be heated is above the required level, the temperature of the sensor liquid rises and expands, causing the piston of the thermostat to act upon the valve, reducing the flow of the heating medium.

Subject to change without notice.

## FUNCTION

If the temperature of the medium to be heated is below the required level, the temperature of the sensor liquid falls, reducing the volume of the liquid, so that the piston allows the valve to open under its internal spring, thus increasing the flow of the heating medium. The neutral zone of a thermostat is the temperature difference which can occur at the sensor without any movement of the valve spindle. This represents the sensitivity of the control system to temperature changes: V2 = 2.5°C, V4 = 2°C and V8 = 1.5°C. (see fig. 2.)

## CHOICE OF TEMPERATURE CONTROL

The selection of the correct temperature controller is determined by the sizing of the valve and thermostat respectively, which may be chosen by using our web-based software "Quick Choice" available on our website.

**Fig. 1** indicates whether the temperature of the heating medium necessitates a cooling unit, and how the thermostat is to be mounted in relation to the valve; for a temperature range -30°C to 170°C the thermostat may be installed both above and below the valve.

**Fig. 2** shows the type designation of the thermostat, its closing force in N and its setting range in °C.

**Fig. 3** shows the choices of length and material for the capillary tubes.

**Fig. 4** shows the different types of sensors.

**Fig. 5** shows the time coefficients for the sensors. **Fig. 6** shows the choices of sensor materials, etc.

**Fig. 7** shows the dimensions and weights of the sensors as well as the weight of adjusting cylinders and the thermostats.

**FIG. 1. TEMPERATURE LIMITS**

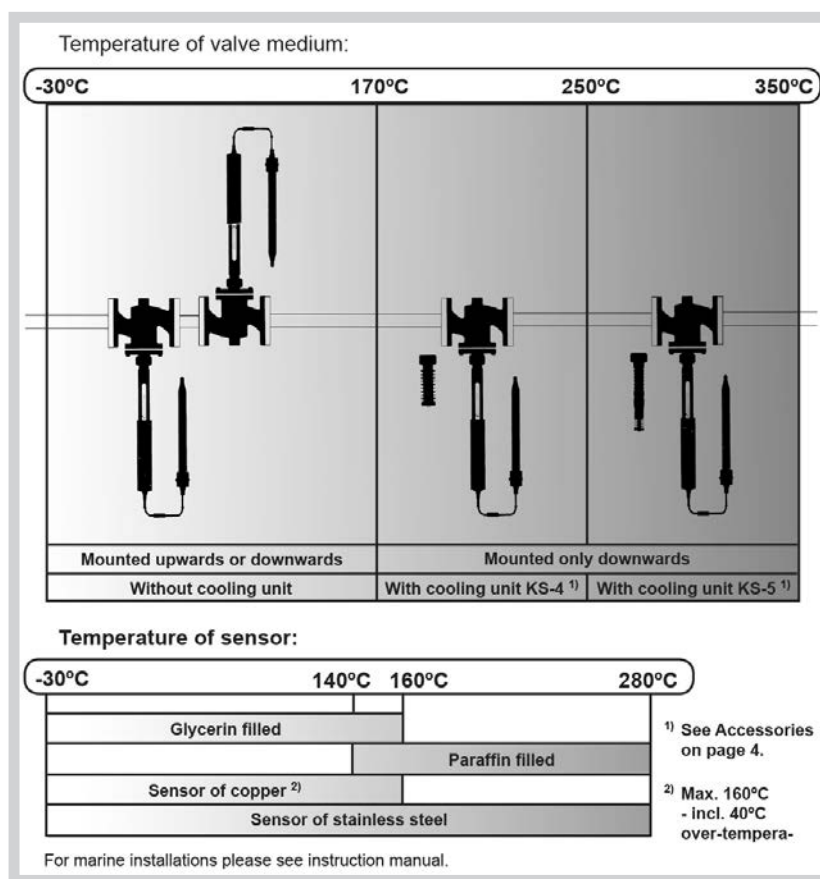

**FIG. 2. TEMPERATURE TYPES**

Technical Data		Thermostat Types					
		V2.05	V4.03	V4.05	V4.10	V8.09	V8.18
Max. closing force	N	400	500	500	500	800	800
Setting range for standard thermostats <sup>1)</sup>	°C	0-60	0-160	0-120	0-60	0-120	0-60
		30-90		40-160	30-90	40-160	30-90
		60-120			60-120		60-120
Neutral zone	°C	2.5	2	2	2	1.5	1.5
For valves with rated travel up to:	mm	10	21	21	21	21	21
Travel (amplification) in range: mm/°C	-30 to 160°C <sup>2)</sup>	0.5	0.3	0.5	1	0.9	1.8
	140 to 280°C <sup>3)</sup>	0.7	0.33	0.7	1.33	1.2	2.4

<sup>1)</sup> Setting ranges from -30 to 280°C on request. - Excess temp. safety range: 40°C<sup>2)</sup> Glycerine<sup>3)</sup> Paraffin

Subject to changes, without notice.

# V2, V4 and V8 Thermostats

Self-acting Temperature Controls

0-3.4.01-L

Page 3 of 6

## Rod Sensor

## Spiral Sensor

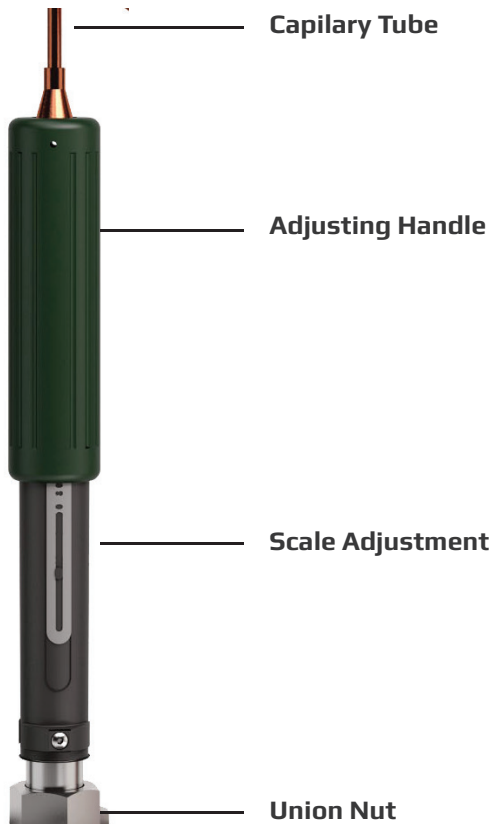
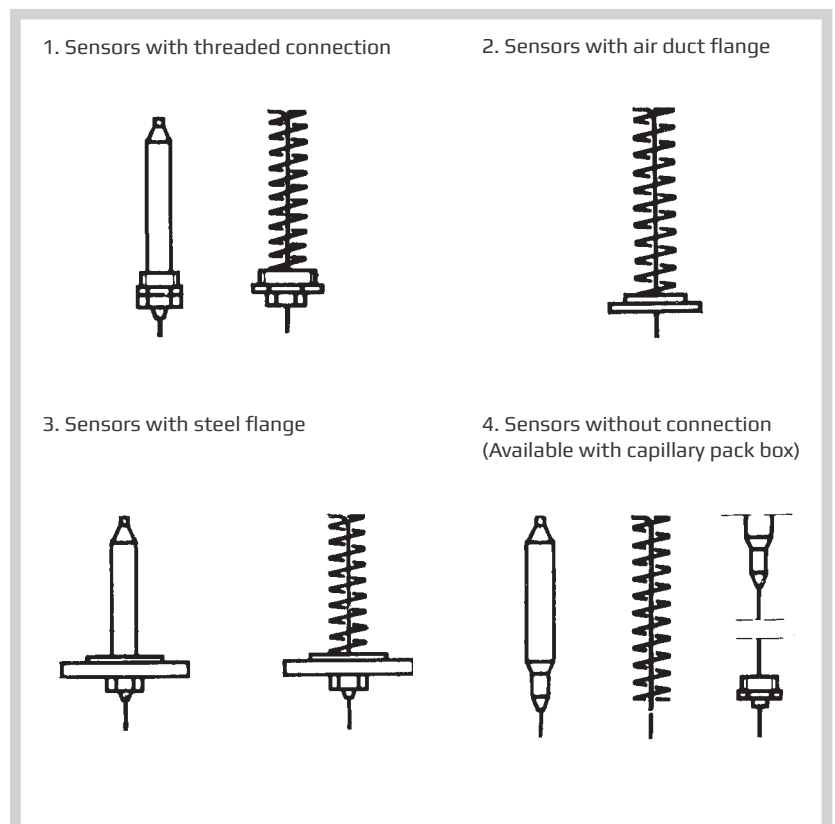

FIG. 3. CAPILLARY TUBES

Choice of capillary tube, length and material, is determined according to the table below, independent of the choice of the thermostat type.

Length	Copper threads	PVC-coated copper	Stainless steel
3 m	✓	✓	✓
4.5 m			✓
6 m	✓	✓	✓
7.5 m			✓
9 m	✓	✓	✓
10.5 m			✓
12 m	✓	✓	✓
13.5 m			✓
15 m	✓	✓	✓
16.5 m			✓
18 m	✓	✓	✓
19.5 m			✓
21 m	✓	✓	✓

FIG. 4. SENSOR TYPES



**FIG. 5. TIME COEFFICIENT FOR SENSORS**

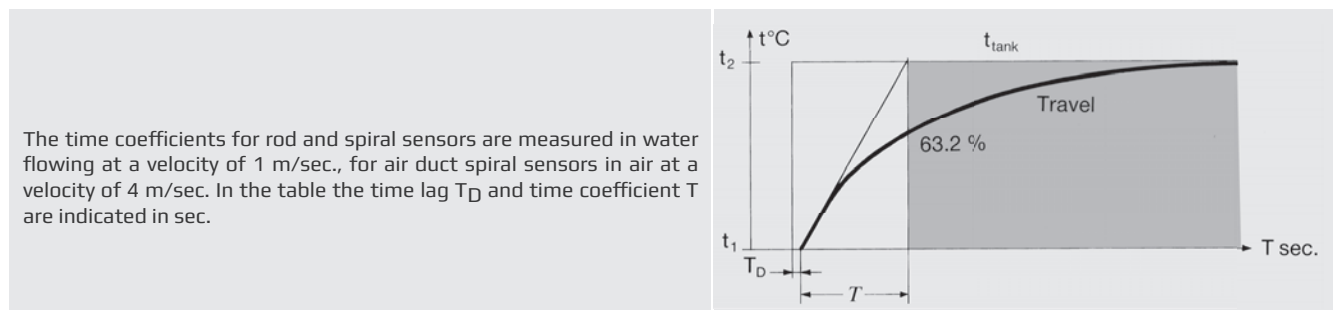

Type	Copper					Acid-resistant stainless steel (mm)				Copper with sensor pocket		
	Rod sensor		Spiral sensor		Spiral sensor for air duct	Rod sensor		Spiral sensor		Rod sensor		Liquid in sensor pocket
	$T_D$	T	$T_D$	T	T	$T_D$	T	$T_D$	T	$T_D$	T	
V2.05	10	85	3	20	360	10	85	3	20	20	210	Hot oil
V4.03	6	120	3	20	360	6	90	3	20	20	250	Hot oil
V4.05	6	130	2	20	360	6	100	2	20	20	200	Hot oil
V4.10	8	165	2	20	360	8	150	2	25	25	300	Hot oil
V8.09	8	165	2	30	600	9	220	2	30	25	450	Hot oil
V8.18						9	280	10	65	28*	570*	Hot oil

**FIG. 6. SENSOR MATERIAL ETC.**

Adjusting Cylinder	Copper sensors				Acid-resistant stainless steel sensors				Capillary tubes
									Copper = c Stainless steel = n
DIN/EN no. Material no.	a 10088 1.4301	b 17440 1.4305	c 1787 2.0090	d OM-Metal	e 17100 1.0134	f 1725 3.2581	h 17440 1.4436	k 17440 1.4435	n 17440 1.4301

**ACCESSORIES**

**Manual Adjusting Device**

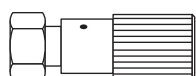

With stuffing box. For tightening and manual operation of the valves, when a thermostat has not been fitted, e.g. during periods of construction etc.

**Cooling Unit KS-4**

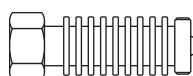

Cooling unit protecting the stuffing box of the thermostat. To be applied at valve temperatures between 170°C and 250°C.

**Cooling Unit KS-5**



Cooling unit with built-in bellows gland. Replaces the stuffing box of thermostat. Must be applied by valve temperatures between 250°C and 350°C.

# V2, V4 and V8 Thermostats

Self-acting Temperature Controls

O-3.4.01-L

Page 5 of 6

FIG. 7. DIMENSIONS AND WEIGHTS

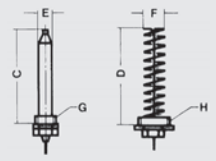
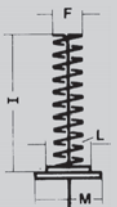
		Thermostat / Sensor material												
		Type V2.05		Type V4.03		Type V4.05		Type V4.10		Type V8.09		Type V8.18		
		c	s	c	s	c	s	c	s	c	s	c	s	
<p>The measurements G and H are pipe threads according to ISO R7/1. All other measurements are mm.</p> <p>Weight: Net.</p> <p>c = Copper sensor.</p> <p>s = Acid-resistant stainless steel sensor.</p>														
<b>Adjusting cylinder</b>    Weights see below	<b>A</b>	305	305	385	385	385	385	385	385	560	560		560	
	<b>B</b>	405	406	525	525	525	525	525	525	740	740		740	
<b>Sensor with threaded connection</b>    Weight incl. G-connection Weight incl. H-connection	<b>C</b>	210	190	210	190	390	380	490	515	710	745		800	
	<b>D</b>	235	170	235	170	235	250	325	325	425	435		810	
	<b>E</b>	22	22	22	22	22	22	28	25	28	25		34	
	<b>F</b>	49	49	49	49	49	49	49	49	49	49		49	
	<b>G</b>	R $\frac{3}{4}$	R $\frac{3}{4}$	R1	R1	R1	R1	R1	R1	R1	R2	R2		R2
	<b>H</b>	R2	R2	R2	R2	R2	R2	R2	R2	R2	R2	R2		R2
	<b>kg</b>	1.8	1.8	2.4	2.4	2.6	2.6	3.3	3.3	6.3	6.3		7.3	
<b>kg</b>	2.3	2.3	2.9	2.9	3.1	3.1	3.8	3.8	6.3	6.3		7.3		
<b>Sensors with air duct flange</b>  	<b>F</b>	49		49		49		49		49				
	<b>I</b>	430		430		430		430		450				
	<b>L</b>	60		60		60		60		60				
	<b>M</b>	95		95		95		95		95				
	<b>kg</b>	1.8		2.4		2.6		3.3		5.8				

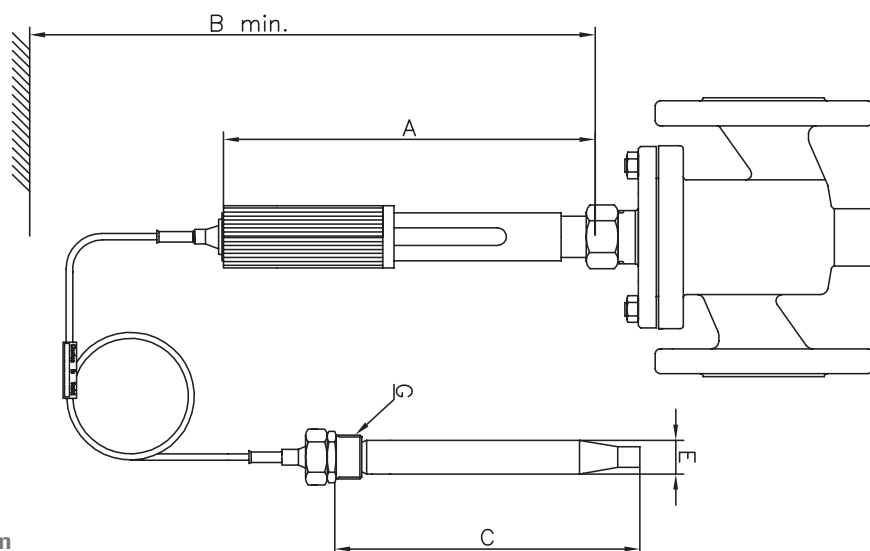

**FIG. 7. DIMENSIONS AND WEIGHTS**

		Thermostat / Sensor material											
		Type V2.05		Type V4.03		Type V4.05		Type V4.10		Type V8.09		Type V8.18	
		c	s	c	s	c	s	c	s	c	s	c	s
<p>The measurements G and H are pipe threads according to ISO R7/1. All other measurements are mm. Weight: Net. c = Copper sensor. s = Acid-resistant stainless steel sensor.</p>													
<p><b>Sensor with steel flange DN 50, PN 40</b></p>	<b>E</b>	22	22	22	22	22	22	28	25	28	25		34
	<b>F</b>	49	49	49	49	49	49	49	49	49	49		49
	<b>N</b>	200	180	200	180	380	360	480	505	700	735		790
	<b>O</b>	225	160	225	160	225	240	315	315	415	425		800
	<b>P</b>	4x18	4x18	4x18	4x18	4x18	4x18	4x18	4x18	4x18	4x18		4x18
	<b>R</b>	125	125	125	125	125	125	125	125	125	125		125
	<b>S</b>	165	165	165	165	165	165	165	165	165	165		165
	<b>T</b>	22	22	22	22	22	22	22	22	22	22		22
	<b>kg</b>	5.3	5.3	5.9	5.9	6.1	6.1	6.8	6.8	9.3	9.3		10.3
	<p><b>Sensor with steel flange DN 50, PN 160</b></p>	<b>E</b>	22	22	22	22	22	22	28	25	28	25	
<b>F</b>		49	49	49	49	49	49	49	49	49	49		49
<b>N</b>		180	160	180	160	360	340	460	485	680	715		770
<b>O</b>		205	140	205	140	205	220	295	295	395	405		780
<b>P</b>		4x27	4x27	4x27	4x27	4x27	4x27	4x27	4x27	4x27	4x27		4x27
<b>R</b>		145	145	145	145	145	145	145	145	145	145		145
<b>S</b>		195	195	195	195	195	195	195	195	195	195		195
<b>T</b>		45	45	45	45	45	45	45	45	45	45		45
<b>kg</b>		11.3	11.3	11.9	11.9	12.1	12.1	12.8	12.8	15.3	15.3		16.3
<p><b>Sensors without connection</b> Available with capillary pack box in stainless steel (1.4436)</p>		<b>E</b>	22	22	22	22	22	22	28	25	28	25	
	<b>F</b>	49	49	49	49	49	49	49	49	49	49		49
	<b>G</b>	R1	R1	R1	R1	R1	R1	R1	R1	R2	R2		R2
	<b>H</b>	R2	R2	R2	R2	R2	R2	R2	R2	R2	R2		R2
	<b>U</b>	250	230	250	230	430	410	535	555	750	785		840
	<b>V</b>	290	220	290	220	290	310	375	370	470	490		860
	<b>kg<sup>1)</sup></b>	1.6	1.6	2.2	2.2	2.3	2.3	3	3	5.5	5.5		6.5
	<b>kg<sup>2)</sup></b>	1.6	1.6	2.2	2.2	2.4	2.4	3.1	3.1	5.6	5.6		6.6
	<b>kg<sup>3)</sup></b>	1.8	1.8	2.4	2.4	2.6	2.6	3.3	3.3	6.3	6.3		7.3
	<b>kg<sup>4)</sup></b>	2.3	2.3	2.9	2.9	3.1	3.1	3.8	3.8	6.3	6.3		7.3

